

S12IV - TRUE UNION 2-WAY Βάνα Σοληνοειδή

2 way solenoid valve with female union ends for solvent welding Function: Normally closed

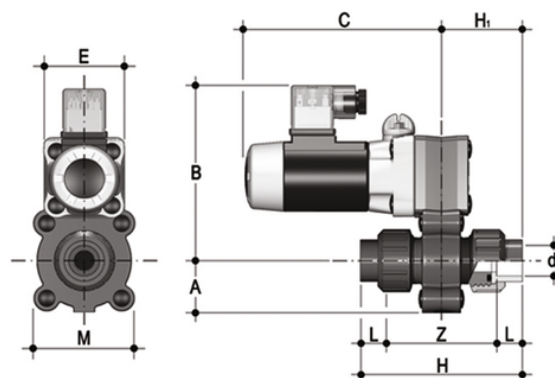

EPDM

Κωδικός προϊόντος

S22IV0816E110A

S22IV0820E110A

S22IV1016E110A

S22IV1020E110A

S22IV1516E110A

S22IV1520E110A

S12IV - TRUE UNION 2-WAY Βάνα Σοληνοειδή

Κωδικός Προϊόντος

S22IV0816F110A

S22IV0820F110A

S22IV1016F110A

S22IV1020F110A

S22IV1516F110A

S22IV1520F110A

S12IV - TRUE UNION 2-WAY Βάνα Σοληνοειδή

- Installation flexibility and ease of maintenance: high-performance solenoid electric actuator with internal moving parts designed to exceed 5 million maintenance free operating cycles. Adjustable circular section coil with IP65 protection class.
 - DIN 43650 electrical connector supplied as standard: includes LED indicator light and rectifier (in the case of an AC coil).
 - Lever shutter in EPDM or FKM and lever in stainless steel.
 - Suitable for use with aggressive fluids: no metal component in contact with the fluid or the external environment; all the screws are covered by PE protection plugs.
 - Emergency override
-
- 2-Way PVC-U body
 - Installation flexibility and ease of maintenance: high-performance solenoid electric actuator designed to exceed 5 million maintenance-free operating cycles
 - Adjustable circular section coil with IP65 protection class.
 - Integrated override with the possibility of being installed in 3 different positions.
 - Lever shutter in EPDM or FKM and lever in stainless steel.
 - DIN 43650 electrical connector supplied as standard: includes LED indicator light and rectifier (in the case of an AC coil).