

S12IV - TRUE UNION 2-WAY Βάνα Σοληνοειδή

2 way solenoid valve with female union ends for solvent welding Function: Normally closed

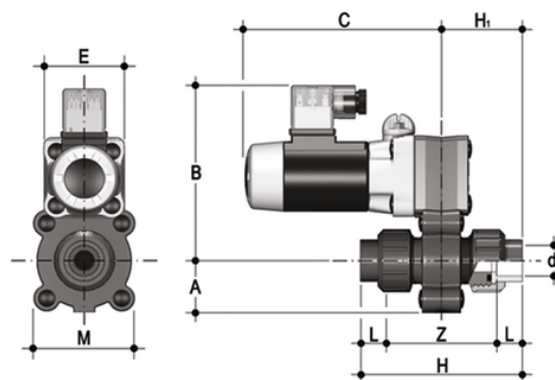

EPDM

Κωδικός προϊόντος	tooltplmage
S22AV0838E012C	-
S22AV0812E012C	-
S22AV1038E012C	-
S22AV1012E012C	-
S22AV1538E012C	-
S22AV1512E012C	-

S12IV - TRUE UNION 2-WAY Βάνα Σοληνοειδή

Κωδικός Προϊόντος	tooltplmage
S22AV0838F012C	-
S22AV0812F012C	-
S22AV1038F012C	-
S22AV1012F012C	-
S22AV1538F012C	-
S22AV1512F012C	-

S12IV - TRUE UNION 2-WAY Βάνα Σοληνοειδή

- Installation flexibility and ease of maintenance: high-performance solenoid electric actuator with internal moving parts designed to exceed 5 million maintenance free operating cycles. Adjustable circular section coil with IP65 protection class.
 - DIN 43650 electrical connector supplied as standard: includes LED indicator light and rectifier (in the case of an AC coil).
 - Lever shutter in EPDM or FKM and lever in stainless steel.
 - Suitable for use with aggressive fluids: no metal component in contact with the fluid or the external environment; all the screws are covered by PE protection plugs.
 - Emergency override
-
- 2-Way PVC-U body
 - Installation flexibility and ease of maintenance: high-performance solenoid electric actuator designed to exceed 5 million maintenance-free operating cycles
 - Adjustable circular section coil with IP65 protection class.
 - Integrated override with the possibility of being installed in 3 different positions.
 - Lever shutter in EPDM or FKM and lever in stainless steel.
 - DIN 43650 electrical connector supplied as standard: includes LED indicator light and rectifier (in the case of an AC coil).