

# FKOV/CE 90-240V AC LUG ISO-DIN DN 65-100 - electrically actuated butterfly valve

LUG ISO-DIN version butterfly valve with multi-volt electric actuator 90-240 V AC 50-60 Hz.

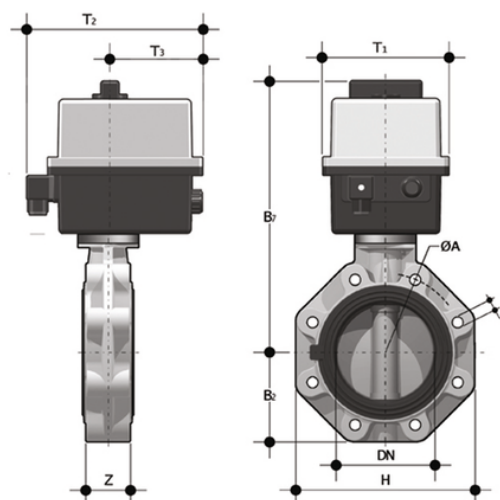

## EPDM

Κωδικός Προϊόντος	tooltplmage
FKOLVEM075E	-
FKOLVEM090E	-
FKOLVEM110E	-

## FKM

Κωδικός Προϊόντος	tooltplmage
FKOLVEM075F	-
FKOLVEM090F	-
FKOLVEM110F	-