

Bend S/S 15°

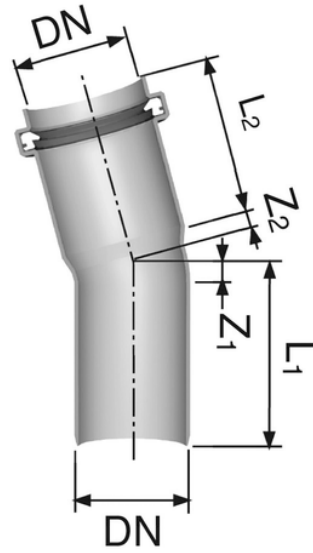
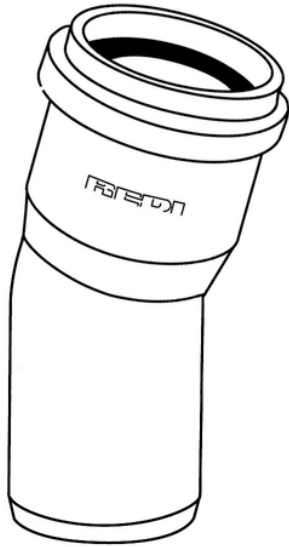

Reference	tooltiplmage	Colour	Z1 (mm)	Z2 (mm)	L1 (mm)	L2 (mm)	DN (mm)
0100411	-	Red RAL 8023	3	27	48	41	40