

ISO-BSP FITTINGS

ADAPTOR FITTINGS



ISO-BSP FITTINGS

Series of fittings designed for conveying fluids under pressure with threaded and solvent weld cold chemical jointing systems (solvent welding) using suitable solvent cement and cleanerprimer.

ADAPTOR FITTINGS

Technical specifications	
Size range	d 16 ÷ d 125 (mm): R 3/8" ÷ 4"
Nominal pressure	PN 16 with water at 20 °C
Temperature range	0 °C ÷ 60 °C
Coupling standards	<p>Solvent welding: ISO 727, EN ISO 15493, EN ISO 1452, ASTM D 2467, JIS K 6743, BS 4346-1. Can be coupled to pipes according to ISO 161-1, EN ISO 1452, EN ISO 15493, DIN 8062, ASTM D1785, JIS K6741, BS 3505-3506</p> <p>Thread: UNI ISO 228-1, EN 10226-1/2, ISO 7, ASTM D 2464, JIS B 0203</p>
Reference standards	<p>Construction criteria: EN ISO 1452, EN ISO 15493</p> <p>Test methods and requirements: EN ISO 1452, EN ISO 15493</p> <p>Installation criteria: DVS 2204, DVS 2221, UNI 11242</p>
Fitting material	PVC-U dark grey RAL 7011
Seal material	EPDM, FKM

TECHNICAL DATA

REGRESSION CURVE FOR PVC-U

Regression coefficients according to EN ISO 1452 and EN ISO 15493 for MRS (minimum required strength) values = 25 N/mm² (MPa) (classification PVC-U 250)

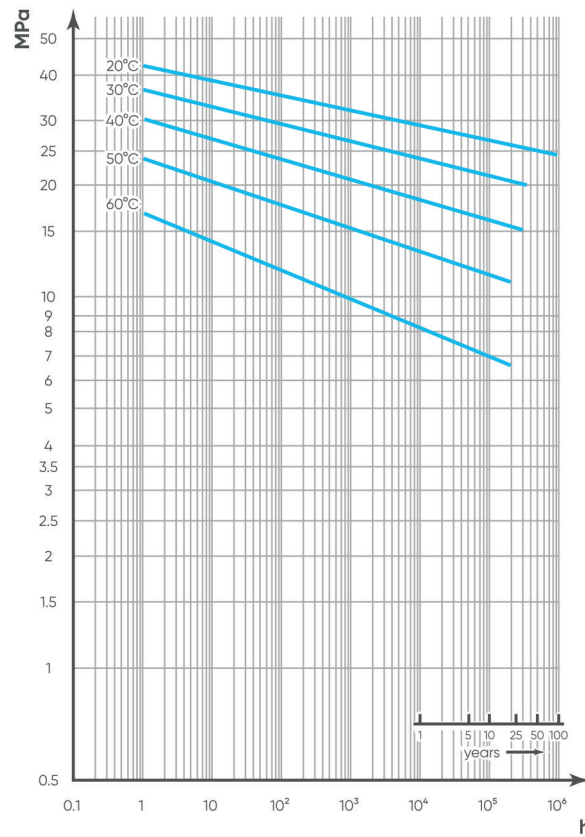

PRESSURE VARIATION ACCORDING TO TEMPERATURE

For water and non-hazardous fluids for which the material is classified as CHEMICALLY RESISTANT (life expectancy 25 years). In other cases, a reduction of the nominal pressure PN is required.

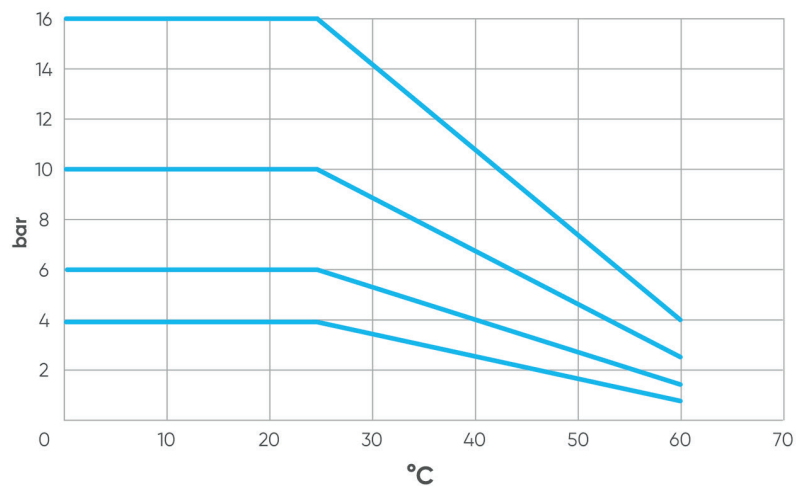

DIMENSIONS

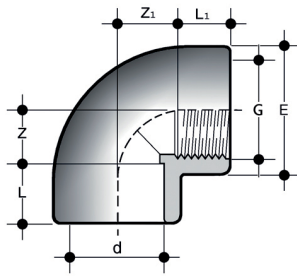

GIFV

90° elbow with solvent weld socket and BSP threaded female end G

d x G	PN	E	L	L ₁	Z	Z ₁	g	Code
16 x 3/8"	16	23,5	14	11,4	10	13	16	GIFV016038
20 x 1/2"	16	28,5	16	15	12	13	24	GIFV020012
25 x 3/4"	16	35	19	16,3	14	17	40	GIFV025034
32 x 1"	16	43	22	19,1	18	20,5	72	GIFV032100
40 x 1 1/4	16	54	26	21,4	22,5	27	125	GIFV040114
50 x 1 1/2	16	61	31	21,4	27	37	175	GIFV050112
63 x 2"	16	76	38	25,7	33	46	320	GIFV063200
75 x 2 1/2	16	91	44	30,2	40,5	55	465	GIFV075212
90 x 3"	16	108	51	33,3	48	65,5	795	GIFV090300
110 x 4"	16	131	61	39,3	60	80	1130	GIFV110400

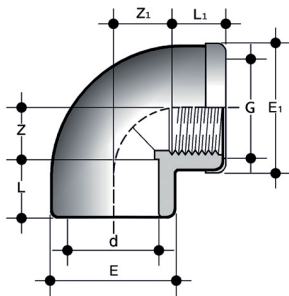

GIMV

90° elbow with reinforced solvent weld socket d and BSP threaded female end G with stainless steel reinforcing ring

d x G	PN	E	E ₁	L	L ₁	Z	Z ₁	g	Code
16 x 3/8"	16	23,5	24,5	14	11,4	10	13	20	GIMV016038
20 x 1/2"	16	28,5	29,5	16	15	12	13	30	GIMV020012
25 x 3/4"	16	35	36	19	16,3	14	17	48	GIMV025034
32 x 1"	16	43	44	22	19,1	18	20,5	85	GIMV032100
40 x 1 1/4	16	54	55	26	21,4	22,5	27	130	GIMV040114
50 x 1 1/2	16	61	62	31	21,4	27	37	185	GIMV050112
63 x 2"	16	76	77	38	25,7	33	46	345	GIMV063200

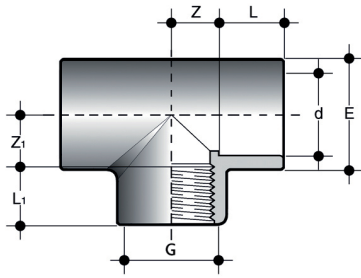

TIFV

90° Tee with solvent weld socket d and BSP threaded female end G

d x G	PN	E	L	L ₁	Z	Z ₁	g	Code
16 x 3/8"	16	23,5	14	11,4	9	11	20	TIFV016038
20 x 1/2"	16	28,5	16	15	12	13	32	TIFV020012
25 x 3/4"	16	35	19	16,3	15	17	52	TIFV025034
32 x 1/2"	16	41	22	15	17,5	18	92	TIFV032012
32 x 1"	16	43	22	19,1	18	21	71	TIFV032100
40 x 1 1/4	16	50	26	21,4	21,5	27	110	TIFV040114
50 x 1/2"	16	61	31	15	27	27,5	160	TIFV050012
50 x 1 1/2	16	61	31	21,4	27	37	195	TIFV050112
63 x 1/2"	16	76	38	15	33,5	37,5	305	TIFV063012
63 x 2"	16	76	38	25,7	33,5	46	405	TIFV063200
75 x 2 1/2	16	91	44	30,2	41	54,5	605	TIFV075212
90 x 3"	16	109	51	33,3	48,5	66	1070	TIFV090300
110 x 4"	16	103	61	39,3	61,5	83	1690	TIFV110400

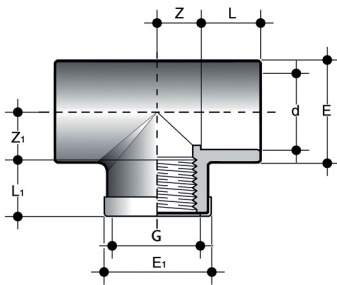

TIMV

90° Tee with reinforced end: solvent weld socket d and BSP threaded female branch G with stainless steel reinforcing ring

d x G	PN	E	E ₁	L	L ₁	Z	Z ₁	g	Code
16 x 3/8"	16	23,5	24,5	14	11,4	9	11	24	TIMV016038
20 x 1/2"	16	28,5	29	16	15	12	13	38	TIMV020012
25 x 3/4"	16	35	36	19	16,3	15	17	60	TIMV025034
32 x 1"	16	43	44	22	19,1	18	21	105	TIMV032100
40 x 1 1/4	16	50	51	26	21,4	21,5	27	125	TIMV040114
50 x 1 1/2	16	61	62	31	21,4	27	37	210	TIMV050112
63 x 2"	16	76	77	38	25,7	33,5	46	415	TIMV063200

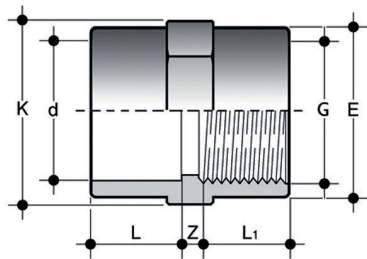

MIFV

Double socket with solvent weld socket d and BSP threaded female end G

d x G	PN	E	K	L	L ₁	Z	g	Code
16 x 3/8"	16	23,5	24	14	11,4	5,5	12	MIFV016038
20 x 1/2"	16	28,5	29	16	15	4	20	MIFV020012
25 x 3/4"	16	35	35	19	16,3	5	30	MIFV025034
32 x 1"	16	42,9	43	22,3	22	2,5	48	MIFV032100
40 x 1 1/4	16	50	50	26,5	21,4	4,5	56	MIFV040114
50 x 1 1/2	16	60	61	31	21,4	7,6	102	MIFV050112
63 x 2"	16	76	76	38	25,7	7,3	181	MIFV063200
75 x 2 1/2	16	89	89	44	30	8	225	MIFV075212
90 x 3"	16	106	106	51	33	9	355	MIFV090300
110 x 4"	16	129	129	61	39	10	555	MIFV110400

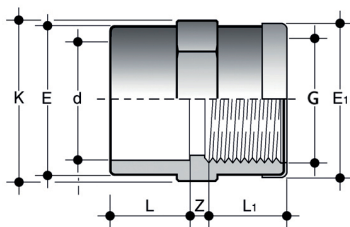

MIMV

Double socket with solvent weld socket d and BSP threaded female end G with stainless steel reinforcing ring

d x G	PN	E	E ₁	K	L	L ₁	Z	g	Code
16 x 3/8"	16	23,5	24,5	24	14	11,4	5,5	14	MIMV016038
20 x 1/2"	16	28,5	29,5	29	16	15	4	23	MIMV020012
25 x 3/4"	16	35	36	35	19	16,3	5	34	MIMV025034
32 x 1"	16	43	44	43	22	19,1	6	53	MIMV032100
40 x 1 1/4	16	50	51	50	26	21,4	5	62	MIMV040114
50 x 1 1/2	16	61	62	61	31	21,4	8	110	MIMV050112
63 x 2"	16	76	77	76	38	25,7	7,5	190	MIMV063200

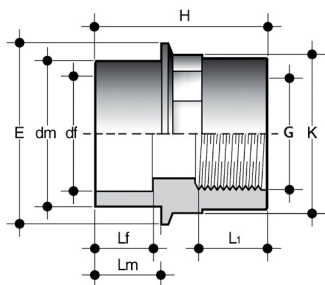

Fig. A

DIFV

Double adaptor with solvent weld socket df , solvent weld spigot dm and BSP threaded female end G (fig. A)

$dm \times df \times G$	PN	E	H	K	L_1	L_f	L_m	g	Code
20 x 16 x 3/8"	16	28	36	24	11,4	14	16	11	DIFV020016038
25 x 20 x 1/2"	16	34	42	29	15	16	19	17	DIFV025020012
32 x 25 x 3/4"	16	40	49	35	16,3	19	22	26	DIFV032025034
40 x 32 x 1"	16	52	57	44	19,1	22	26	49	DIFV040032100
50 x 40 x 1 1/4"	16	59	67	54	21,4	26	31	66	DIFV050040114
63 x 50 x 1 1/2"	16	70	77	64	21,4	31	38	129	DIFV063050112

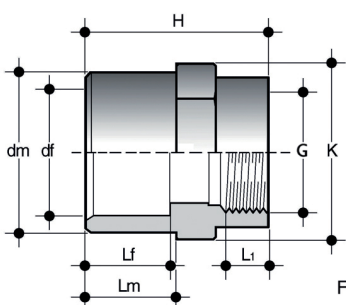

Fig. B

DIFV

Double adaptor with solvent weld socket df , solvent weld spigot dm and BSP threaded female end G (fig. B)

$dm \times df \times G$	PN	E	H	K	L_1	L_f	L_m	g	Code
20 x 16 x 1/2"	16	-	39	30	15	14	16	18	DIFV020016012
25 x 20 x 3/4"	16	-	45	36	16,3	16	19	28	DIFV025020034
32 x 25 x 1"	16	-	51	46	19,1	19	22	49	DIFV032025100
40 x 32 x 1 1/4"	16	-	62	54	21,4	22	26	74	DIFV040032114
50 x 40 x 1 1/2"	16	-	72	65	21,4	26	31	127	DIFV050040112
63 x 50 x 2"	16	-	86	80	25,7	31	38	190	DIFV063050200
75 x 63 x 2"	16	-	76	76	25,7	38	44	180	DIFV075063200
75 x 63 x 2 1/2"	16	-	99	95	30,2	38	44	280	DIFV075063212
90 x 75 x 2 1/2"	16	-	84	95	30,2	44	51	300	DIFV090075212
90 x 75 x 3"	16	-	114	110	33,3	44	51	470	DIFV090075300
110 x 90 x 3"	16	-	100	110	33,3	51	61	450	DIFV110090300
110 x 90 x 4"	16	-	134	130	39,3	51	61	670	DIFV110090400
125 x 110 x 4"	16	-	111	131	39,3	61	69	550	DIFV125110400

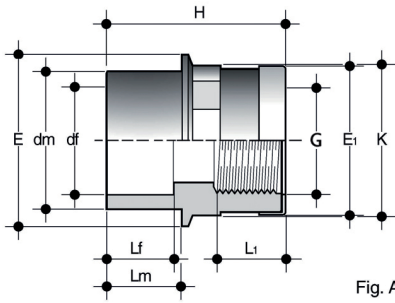

Fig. A

DIMV

Double adaptor with solvent weld socket df , solvent weld spigot dm and BSP threaded female end G with stainless steel reinforcing ring (fig. A)

$dm \times df \times G$	PN	E	E_i	H	K	L_i	L_f	L_m	g	Code
20 x 16 x 3/8"	16	28	24,5	37	24	11,4	14	16	13	DIMV020016038
25 x 20 x 1/2"	16	34	29,5	43	29	15	16	19	20	DIMV025020012
32 x 25 x 3/4"	16	40	36	50	35	16,3	19	22	32	DIMV032025034
40 x 32 x 1"	16	52	44	58	44	19,1	22	26	58	DIMV040032100
50 x 40 x 1 1/4"	16	59	55	68	54	21,4	26	31	77	DIMV050040114
63 x 50 x 1 1/2"	16	70	62	78	64	21,4	31	38	143	DIMV063050112

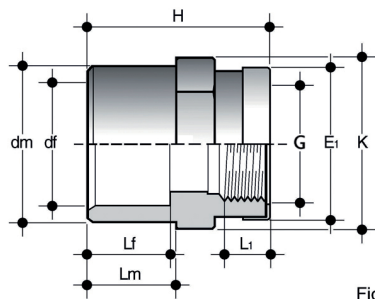
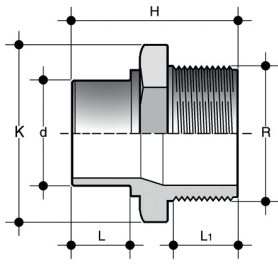

Fig. B

DIMV

Double adaptor with solvent weld socket df , solvent weld spigot dm and BSP threaded female end G with stainless steel reinforcing ring (fig. B)

$dm \times df \times G$	PN	E	E_i	H	K	L	L_f	L_m	g	Code
20 x 16 x 1/2"	16	-	29,5	40	30	15	14	16	21	DIMV020016012
25 x 20 x 3/4"	16	-	36	46	36	16,3	16	19	34	DIMV025020034
32 x 25 x 1"	16	-	44	52	46	19,1	19	22	58	DIMV032025100
40 x 32 x 1 1/4"	16	-	55	63	54	21,4	22	26	85	DIMV040032114
50 x 40 x 1 1/2"	16	-	62	73	65	21,4	26	31	141	DIMV050040112
63 x 50 x 2"	16	-	77	87	80	25,7	31	38	212	DIMV063050200
75 x 63 x 2"	16	-	77	77	76	25,7	38	44	202	DIMV075063200



NRIV

Barrel nipple with reduced solvent weld spigot d and BSP threaded male end R

d x R	PN	E	H	K	L	g	Code
25 x 1"	16	53	60	46	26	43	NRIV025100
32 x 1 1/4"	16	63	66	55	28	70	NRIV032114

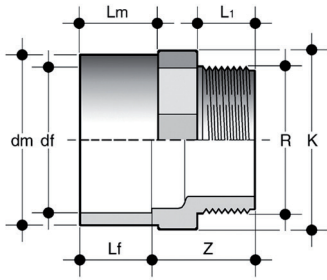

KIFV

Double adaptor with solvent weld socket df, solvent weld spigot dm and BSP threaded male end R

dm x df x R	PN	K	L	Lm	Lf	Z	g	Code
16 x 12 x 3/8"	16	19	11.4	14	12	22	4	KIFV016012038
20 x 16 x 3/8"	16	24	11.4	16	14	25.5	6	KIFV020016038
20 x 16 x 1/2"	16	24	15	16	14	30	15	KIFV020016012
25 x 20 x 1/2"	16	30	15	19	16	30	15	KIFV025020012
25 x 20 x 3/4"	16	30	16.3	19	16	31	20	KIFV025020034
32 x 25 x 1/2"	16	36	15	22	19	30	25	KIFV032025012
32 x 25 x 3/4"	16	36	16.3	22	19	31.5	25	KIFV032025034
32 x 25 x 1"	16	36	19,1	22	19	34	45	KIFV032025100
40 x 32 x 3/4"	16	46	16.3	26	22	32	40	KIFV040032034
40 x 32 x 1"	16	46	19,1	26	22	35	40	KIFV040032100
40 x 32 x 1 1/4"	16	46	21.4	26	22	37	55	KIFV040032114
50 x 40 x 1"	16	55	19,1	31	26	38	70	KIFV050040100
50 x 40 x 1 1/4"	16	55	21.4	31	26	40.5	70	KIFV050040114
50 x 40 x 1 1/2"	16	55	21.4	31	26	40.5	70	KIFV050040112
63 x 50 x 1 1/4"	16	65	21.4	38	31	42.5	70	KIFV063050114
63 x 50 x 1 1/2"	16	65	21.4	38	31	42.5	115	KIFV063050112
63 x 50 x 2"	16	65	25.7	38	31	47	125	KIFV063050200
75 x 63 x 1 1/2"	16	75	21.4	44	38	41	198	KIFV075063112
75 x 63 x 2"	16	75	25.7	44	38	46	160	KIFV075063200
75 x 63 x 2 1/2"	16	80	30.2	44	38	52.5	195	KIFV075063212
90 x 75 x 2"	16	95	25.7	51	44	49	275	KIFV090075200
90 x 75 x 2 1/2"	16	95	30.2	51	44	54	280	KIFV090075212
90 x 75 x 3"	16	95	33.5	51	44	56	300	KIFV090075300
110 x 90 x 2 1/2"	16	110	30.2	61	51	57	370	KIFV110090212
110 x 90 x 3"	16	110	33.5	61	51	62	390	KIFV110090300
110 x 90 x 4"	16	128	39,2	61	51	77	420	KIFV110090400
125 x 110 x 3"	16	128	33.5	69	61	59	450	KIFV125110300
125 x 110 x 4"	16	128	39,2	69	61	65	500	KIFV125110400

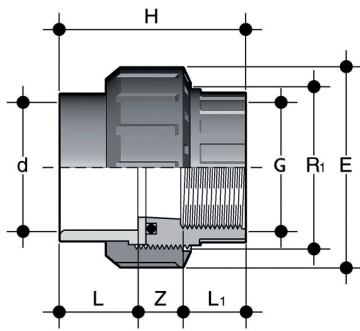

BIFV

Union with solvent weld socket d and BSP threaded female end G with O-Ring in EPDM

d x G	R ₁	PN	E	H	L	L ₁	Z	g	Code
16 x 3/8"	3/4"	16	33	41	14	11,4	15,6	22	BIFV016038E
20 x 1/2"	1"	16	41	45	16	15	14	35	BIFV020012E
25 x 3/4"	1 1/4"	16	50	51	19	16,3	15,7	62	BIFV025034E
32 x 1"	1 1/2"	16	58	57	22	19,1	15,9	85	BIFV032100E
40 x 1 1/4"	2"	16	72	67	26	21,4	19,6	145	BIFV040114E
50 x 1 1/2"	2 1/4"	16	79	72	31	21,4	19,6	180	BIFV050112E
63 x 2"	2 3/4"	16	98	88	38	25,7	24	315	BIFV063200E
75 x 2 1/2"	3 1/2"	10	120	116	44	30,2	34,8	630	BIFV075212E
90 x 3"	4"	10	135	125	51	33,3	40,7	810	BIFV090300E
110 x 4"	5"	10	163	145	61	39,3	44,7	1350	BIFV110400E

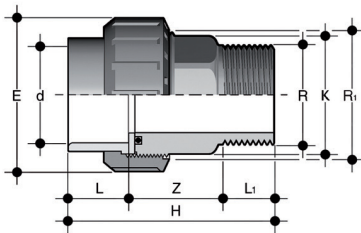

BIRV

Union with fixed BSP threaded male end and O-Ring in EPDM

d x R	R ₁	PN	E	H	K	L	L ₁	Z	g	Code
50 x 1 1/2"	2 1/4"	16	79	98	53	31	21,4	45,6	200	BIRV050112E
50 x 2"	2 1/4"	16	79	102	53	31	25,7	45,3	220	BIRV050200E
63 x 2"	2 3/4"	16	98	116	67	38	25,7	52,3	380	BIRV063200E

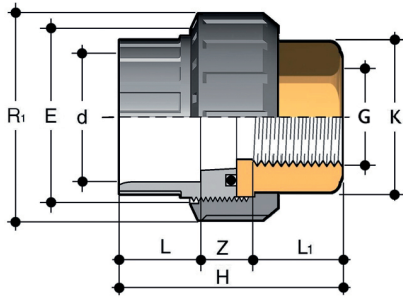

BIFOV

Adaptor union in PVC-U/brass with solvent weld socket d and BSP threaded brass female end G with O-Ring in EPDM

d x G	R ₁	PN	E	H	K	L	L ₁	Z	g	Code
16 x 3/8"	3/4"	16	33	45,5	20	14	13,5	18	53	BIFOV016038E
20 x 1/2"	1"	16	41	48,5	25	16	16,5	16	86	BIFOV020012E
25 x 3/4"	1 1/4"	16	50	54,5	32	19	18,5	17	161	BIFOV025034E
32 x 1"	1 1/2"	16	58	59,5	38	22	19,5	18	181	BIFOV032100E
40 x 1 1/4"	2"	16	72	68,5	48	26	21,5	21	373	BIFOV040114E
50 x 1 1/2"	2 1/4"	16	79	84,5	55	31	23	24,5	460	BIFOV050112E
63 x 2"	2 3/4"	16	98	94,5	69	38	27	29,5	824	BIFOV063200E

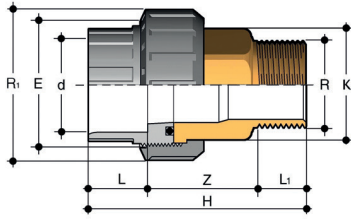

BIROV

Adaptor union in PVC-U/brass with solvent weld socket d and BSP threaded brass male end R with O-Ring in EPDM

d x R	R ₁	PN	E	H	K	L	L ₁	Z	g	Code
16 x 3/8"	3/4"	16	33	58,5	20	14	10,5	34	79	BIROV016038E
20 x 1/2"	1"	16	41	65	25	16	13,5	35,5	131	BIROV020012E
25 x 3/4"	1 1/4"	16	50	72,5	32	19	15	38,5	229	BIROV025034E
32 x 1"	1 1/2"	16	58	80	38	22	17,5	40,5	188	BIROV032100E
40 x 1 1/4"	2"	16	72	91	48	26	19,5	45,5	550	BIROV040114E
50 x 1 1/2"	2 1/4"	16	79	101	55	31	19,5	50,5	681	BIROV050112E
63 x 2"	2 3/4"	16	98	122,5	69	38	24	60,5	1183	BIROV063200E

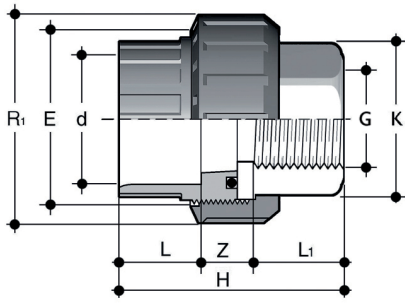

BIFXV

Adaptor union in PVC-U/stainless steel with solvent weld socket d and BSP threaded A316L stainless steel female end G with O-Ring in EPDM or FKM

d x G	R ₁	PN	E	H	K	L	L ₁	Z	g	EPDM code	FKM code
16 x 3/8"	3/4"	16	33	45,5	20	14	13,5	18	50	BIFXV016038E	BIFXV016038F
20 x 1/2"	1"	16	41	48,5	25	16	16,5	16	81	BIFXV020012E	BIFXV020012F
25 x 3/4"	1 1/4"	16	50	54,5	32	19	18,5	17	152	BIFXV025034E	BIFXV025034F
32 x 1"	1 1/2"	16	58	59,5	38	22	19,5	18	170	BIFXV032100E	BIFXV032100F
40 x 1 1/4"	2"	16	72	68,5	48	26	21,5	21	353	BIFXV040114E	BIFXV040114F
50 x 1 1/2"	2 1/4"	16	79	84,5	55	31	23	30,5	435	BIFXV050112E	BIFXV050112F
63 x 2"	2 3/4"	16	98	94,5	69	38	27	29,5	779	BIFXV063200E	BIFXV063200F

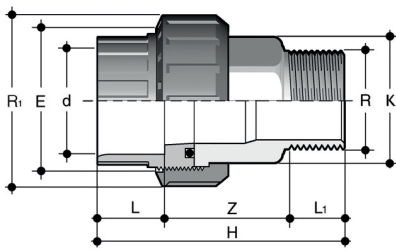

BIRXV

Adaptor union in PVC-U/stainless steel with solvent weld socket d and BSP threaded A316L stainless steel male end R with O-Ring in EPDM or FKM

d x R	R ₁	PN	E	H	K	L	L ₁	Z	g	EPDM code	FKM code
16 x 3/8"	3/4"	16	33	58,5	20	14	10,5	34	74	BIRXV016038E	BIRXV016038F
20 x 1/2"	1"	16	41	65	25	16	13,5	35,5	123	BIRXV020012E	BIRXV020012F
25 x 3/4"	1 1/4"	16	50	72,5	32	19	15	38,5	215	BIRXV025034E	BIRXV025034F
32 x 1"	1 1/2"	16	58	80	38	22	17,5	40,5	269	BIRXV032100E	BIRXV032100F
40 x 1 1/4"	2"	16	72	91	48	26	19,5	45,5	516	BIRXV040114E	BIRXV040114F
50 x 1 1/2"	2 1/4"	16	79	101	55	31	19,5	50,5	639	BIRXV050112E	BIRXV050112F
63 x 2"	2 3/4"	16	98	122,5	69	38	24	60,5	1111	BIRXV063200E	BIRXV063200F

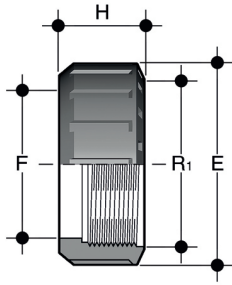

EFV

Union nut with BSP thread for union types BIV, BIFV, BFV, BLV, BIRV, BIFOV, BIROV, BIFXV, BIRXV.

R ₁	d BIV	PN	E	F	H	g	Code
1/2"	-	16	27	17	24	8	EFV012
3/4"	16	16	33	22	21	9	EFV034
1"	20	16	41	28	22	13	EFV100
1 1/4"	25	16	50	36	25	22	EFV114
1 1/2"	32	16	58	42	27	30	EFV112
2"	40	16	72	53	30	50	EFV200
2 1/4"	50	16	79	59	34	68	EFV214
2 1/2"	-	16	90	68	36	95	EFV212
2 3/4"	63	16	98	74	38	120	EFV234
3 1/2"	75	10	120	93	45	198	EFV312
4"	90	10	135	106	52	278	EFV400
5"	110	10	163	129	60	448	EFV500

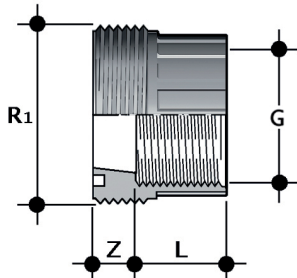

F/BFV

Union bush with BSP threaded female end for union types BIV, BIFV, BFV, BLV, BIRV, BIFOV, BIROV, BIFXV, BIRXV

G	R ₁	PN	L ₁	Z	g	Code
3/8"	3/4"	16	11,4	12,6	8	FBFV038
1/2"	1"	16	15	11	13	FBFV012
3/4"	1 1/4"	16	16,3	12,7	22	FBFV034
1"	1 1/2"	16	19,1	12,9	32	FBFV100
1 1/4"	2"	16	21,4	16,6	57	FBFV114
1 1/2"	2 1/4"	16	21,4	16,5	64	FBFV112
2"	2 3/4"	16	25,7	20,5	122	FBFV200

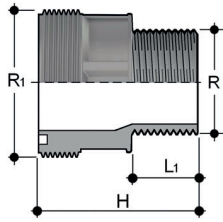

F/BRV

Union bush with BSP threaded male end for union types BIV, BIFV, BFV, BLV, BIRV, BIFOV, BIOV, BIFXV, BIRXV

R	R ₁	PN	L _i	g	Code
1 1/2"	2 1/4"	16	22,5	100	FBRV112214
2"	2 1/4"	16	27	120	FBRV200214
2"	2 3/4"	16	27	175	FBRV200234

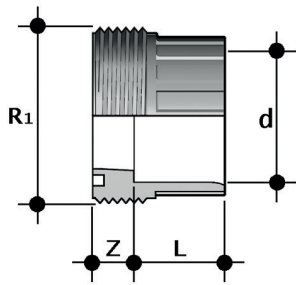

F/BIV

Union bush for solvent welding, metric series for union types BIV, BIFV, BFV, BLV, BIRV, BIFOV, BIOV, BIFXV, BIRXV

d	R ₁	PN	L	Z	g	Code
16	3/4"	16	14	10	9	FBIV016
20	1"	16	16	10	13	FBIV020
25	1 1/4"	16	19	10	25	FBIV025
32	1 1/2"	16	22	10	31	FBIV032
40	2"	16	26	12	58	FBIV040
50	2 1/4"	16	31	14	63	FBIV050
63	2 3/4"	16	38	19	119	FBIV063
75	3 1/2"	10	44	18	230	FBIV075
90	4"	10	51	18	290	FBIV090
110	5"	10	61	18	500	FBIV110

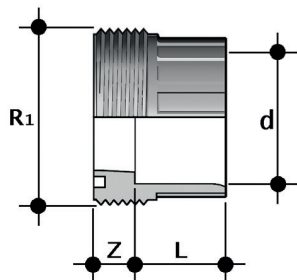

F/BLV

Union bush for solvent welding, series BS for union types BIV, BIFV, BFV, BLV, BIRV, BIFOV, BIROV, BIFXV, BIRXV

d	R ₁	PN	L	Z	g	Code
1/2"	1"	16	16	10	12,5	FBLV012
3/4"	1 1/4"	16	19	10	22,5	FBLV034
1"	1 1/2"	16	22	10	30	FBLV100
1 1/4"	2"	16	26	12	52	FBLV114
1 1/2"	2 1/2"	16	31	14	69,5	FBLV112
2"	2 3/4"	16	38	19	133,5	FBLV200

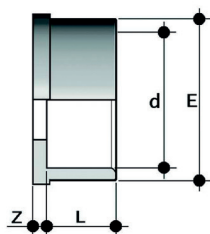

Q/BIV

Union end for solvent welding, metric series for union types BIV, BIFV, BFV, BLV, BIRV, BIFOV, BIROV, BIFXV, BIRXV

d	PN	E	L	Z	g	Code
16	16	22	14	3	5	QBIV016
20	16	28	16	3	8	QBIV020
25	16	36	19	3	15	QBIV025
32	16	42	22	3	24	QBIV032
40	16	53	26	3	37	QBIV040
50	16	59	31	3	42	QBIV050
63	16	74	38	3	77	QBIV063
75	10	93	44	3	150	QBIV075
90	10	105	51	5	192	QBIV090
110	10	129	61	5	335	QBIV110

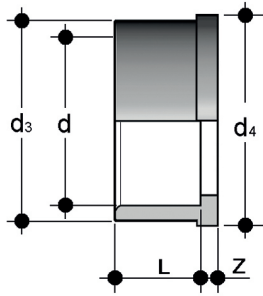

Q/BLV

Union end for solvent welding, BS series for union types BIV, BIFV, BFV, BLV, BIRV, BIFOV, BIROV, BIFXV, BIRXV

d	PN	d ₃	d ₄	L	Z	g	Code
1/2"	16	27,5	30,1	16	3	8	QBLV012
3/4"	16	36	38,8	19	3	13	QBLV034
1"	16	41,5	44,7	22	3	19	QBLV100
1 1/4"	16	53	56,5	26	3	32	QBLV114
1 1/2"	16	59	62,6	31	3	46	QBLV112
2"	16	74	78,4	38	3	86	QBLV200

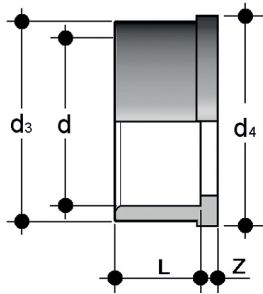

Q/BAV

Union end for solvent welding, ASTM series for union types BIV, BIFV, BFV, BLV, BIRV, BIFOV, BIROV, BIFXV, BIRXV

d	PN	d ₃	d ₄	L	Z	g	Code
1/2"	16	27,5	30,1	22,7	3,5	15,5	QBAV012
3/4"	16	36	38,8	25,9	3,7	22,5	QBAV034
1"	16	41,5	44,7	29,2	3	32,5	QBAV100
1 1/4"	16	53	56,5	32	5	57	QBAV114
1 1/2"	16	59	62,6	35	5	78	QBAV112
2"	16	74	78,4	38,5	5,5	130	QBAV200

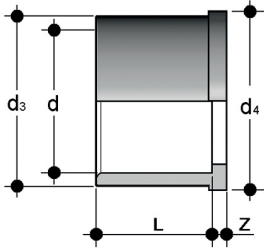

Q/BJV

Union end for solvent welding, JIS series for union types BIV, BIFV, BFV, BLV, BIRV, BIFOV, BIROV, BIFXV, BIRXV

d	PN	d ₃	d ₄	L	Z	g	Code
1/2"	16	27,5	30,1	30	3	16	QBJV012
3/4"	16	36	38,8	35	3,5	21	QBJV034
1"	16	41,5	44,7	40	3	40	QBJV100
1"1/4	16	53	56,5	44	3	68	QBJV114
1"1/2	16	59	62,6	55	4,5	105	QBJV112
2"	16	74	78,4	62,9	5,5	175	QBJV200

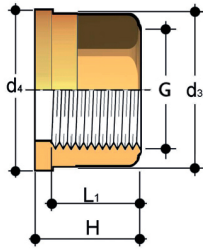

Q/BFO

Union end in brass with female BSP thread for union types BIV, BIFV, BFV, BLV, BIRV, BIFOV, BIROV, BIFXV, BIRXV

G	d ₃	d ₄	H	L ₁	g	Code
3/8"	22	24	21,5	13,5	38	QBFO038
1/2"	27,5	30,1	22,5	16,5	60	QBFO012
3/4"	36	38,8	25,5	18,5	116	QBFO034
1"	41,5	44,7	27,5	19,5	144	QBFO100
1 1/4"	53	56,5	30,5	21,5	260	QBFO114
1 1/2"	59	62,6	33,5	23	325	QBFO112
2"	74	78,4	38,5	27	578	QBFO200

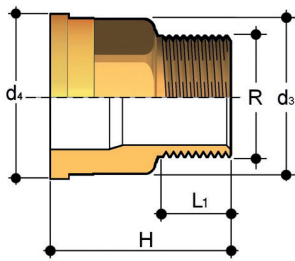

Q/BRO

Union end in brass with male BSP thread for union types BIV, BIFV, BFV, BLV, BIRV, BIFOV, BIROV, BIFXV, BIRXV

R	d ₃	d ₄	H	L ₁	g	Code
3/8"	22	24	34,5	10,5	64	QBRO038
1/2"	27,5	30,1	39	13,5	105	QBRO012
3/4"	36	38,8	43,5	15	184	QBRO034
1"	41,5	44,7	48	17,5	251	QBRO100
1 1/4"	53	56,5	53	19,5	437	QBRO114
1 1/2"	59	62,6	56	19,5	545	QBRO112
2"	74	78,4	65,5	24	937	QBRO200

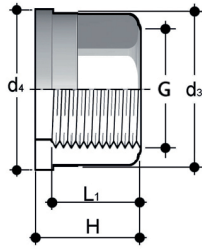

Q/BFX

Union end in A316L stainless steel with female BSP thread for union types BIV, BIFV, BFV, BLV, BIRV, BIFOV, BIROV, BIFXV, BIRXV

G	d ₃	d ₄	H	L ₁	g	Code
3/8"	22	24	21,5	13,5	34	QBFX038
1/2"	27,5	30,1	22,5	16,5	54	QBFX012
3/4"	36	38,8	25,5	18,5	104	QBFX034
1"	41,5	44,7	27,5	19,5	130	QBFX100
1 1/4"	53	56,5	30,5	21,5	234	QBFX114
1 1/2"	59	62,6	33,5	23	293	QBFX112
2"	74	78,4	38,5	27	520	QBFX200

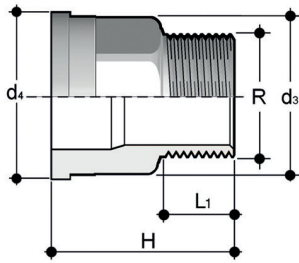

Q/BRX

Union end in A316L stainless steel with male BSP thread for union types BIV, BIFV, BFV, BLV, BIRV, BIFOV, BIROV, BIFXV, BIRXV

R	d ₃	d ₄	H	L ₁	g	Code
3/8"	22	24	34,5	10,5	58	QBRX038
1/2"	27,5	30,1	39	13,5	95	QBRX012
3/4"	36	38,8	43,5	15	166	QBRX034
1"	41,5	44,7	48	17,5	226	QBRX100
1 1/4"	53	56,5	53	19,5	393	QBRX114
1 1/2"	59	62,6	56	19,5	491	QBRX112
2"	74	78,4	65,5	24	843	QBRX200

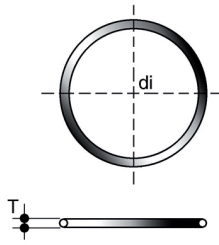

O-RING

O-Ring for union types BIV, BIFV, BFV, BLV, BIRV, BIFOV, BIROV, BIFXV, BIRXV

Union d	C	di	T	d	EPDM code	FKM code
16	3062	15,54	2,62	16	OR3062E	OR3062F
20	4081	20,22	3,53	20	OR4081E	OR4081F
25	4112	28,17	3,53	25	OR4112E	OR4112F
32	4131	32,93	3,53	32	OR4131E	OR4131F
40	6162	40,65	5,34	40	OR6162E	OR6162F
50	6187	47	5,34	50	OR6187E	OR6187F
63	6237	59,69	5,34	63	OR6237E	OR6237F
75	6300	75,57	5,34	75	OR6300E	OR6300F
90	6362	91,45	5,34	90	OR6362E	OR0185F
110	6450	113,67	5,34	110	OR6450E	OR6450F

all resale products

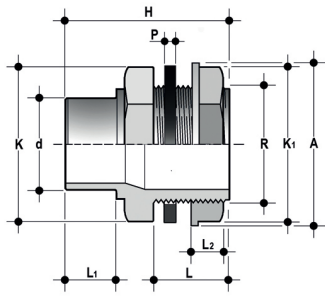

LIV

Tank connector with solvent weld spigot d, threaded joint R with tightening nut and flat gasket in EPDM

d x R	PN	A	H	K	K ₁	L	L ₁	L ₂	P	g	Code
25 x 1"	16	58	60	46	46	26	19	16	2	58	LIV025100
32 x 1 1/4"	16	62	66	55	50	28	22	18	2	90	LIV032114