

# Raccordi ISO-BSP

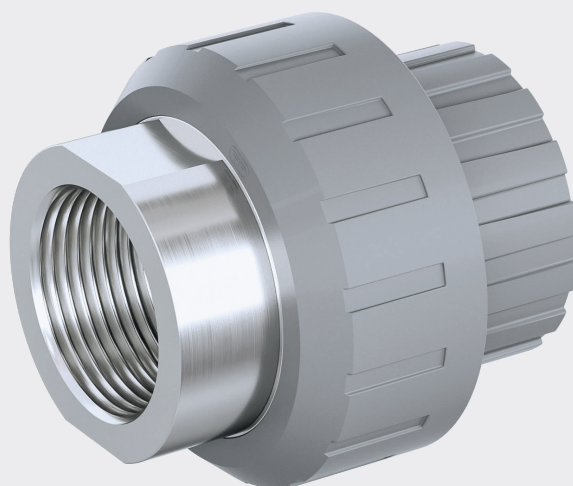

Raccordi TemperFIP100<sup>®</sup> di passaggio



# RACCORDI ISO-BSP

Serie di raccordi destinati al convogliamento di fluidi in pressione con sistema di giunzione mediante filettatura e saldatura chimica a freddo (incollaggio) attraverso l'utilizzo di idoneo collante (TemperGLUE WELD-ON) e primerdetergente.

## RACCORDI TEMPERFIP100<sup>®</sup> DI PASSAGGIO

Specifiche tecniche	
<b>Gamma dimensionale</b>	d 16 ÷ 63 (mm); R 3/8" ÷ 2"
<b>Pressione nominale</b>	PN 16 con acqua a 20 °C
<b>Campo di temperatura</b>	0 °C ÷ 100 °C
<b>Standard di accoppiamento</b>	<b>Incollaggio:</b> EN ISO 15493 Accoppiabili con tubi secondo EN ISO 15493 <b>Filettatura:</b> ISO 228-1, EN 10226-1/2
<b>Riferimenti normativi</b>	<b>Criteri Costruttivi:</b> EN ISO 15493 <b>Metodi e requisiti dei test:</b> EN ISO 15493 <b>Criteri di installazione:</b> DVS 2204, DVS 2221, UNI 11242
<b>Materiale raccordi</b>	PVC-C
<b>Materiali tenuta</b>	EPDM, FKM

# DIMENSIONI

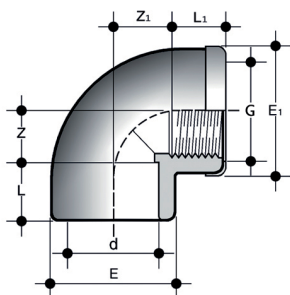

## GIMC

Gomito a 90° con rinforzo estremità d a bicchiere per incollaggio, estremità R femmina filettata BSP munita di anello di rinforzo in Acciaio INOX

d x R	PN	E	E <sub>1</sub>	L	L <sub>1</sub>	Z	Z <sub>1</sub>	g	Codice
16 x 3/8"	16	23,5	24,5	14	11,4	10	13	22	GIMC016038
20 x 1/2"	16	28,5	29,5	16	15	12	13	33	GIMC020012
25 x 3/4"	16	35	36	19	16,3	14	17	53	GIMC025034
32 x 1"	16	43	44	22	19,1	18	20,5	94	GIMC032100
40 x 1 1/4"	16	50	51	26	21,4	22	27	104	GIMC040114
50 x 1 1/2"	16	61	62	31	21,4	27	37	203	GIMC050112
63 x 2"	16	76	77	38	25,7	33	46	380	GIMC063200

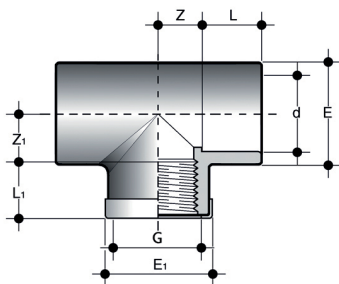

## TIMC

Ti a 90° con rinforzo estremità d a bicchiere per incollaggio, estremità R femmina filettata BSP munita di anello di rinforzo in Acciaio INOX

d x R	PN	E	E <sub>1</sub>	L	L <sub>1</sub>	Z	Z <sub>1</sub>	g	Codice
16 x 3/8"	16	23,5	24,5	14	11,4	9	11	25	TIMC016038
20 x 1/2"	16	28,5	29,5	16	15	12	13	40	TIMC020012
25 x 3/4"	16	35	36	19	16,3	15	17	63	TIMC025034
32 x 1"	16	43	44	22	19,1	18	21	118	TIMC032100
40 x 1 1/4"	16	50	51	26	21,4	21,5	27	137	TIMC040114
50 x 1 1/2"	16	61	62	31	21,4	27	37	231	TIMC050112
63 x 2"	16	76	77	38	25,7	33,5	46	457	TIMC063200

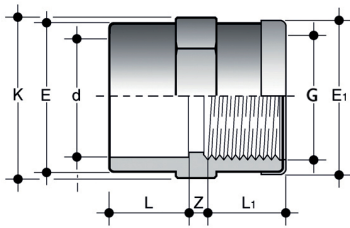

## MIMC

Manicotto estremità d a bicchiere per incollaggio, estremità r femmina filettata BSP con anello di rinforzo in Acciaio INOX

d x R	PN	E	E <sub>1</sub>	K	L	L <sub>1</sub>	Z	g	Codice
16 x 3/8"	16	23,5	24,5	24	14	11,4	5,6	15	MIMC016038
20 x 1/2"	16	28,5	29,5	29	16	15	4	25	MIMC020012
25 x 3/4"	16	35	36	35	19	16,3	5	38	MIMC025034
32 x 1"	16	43	44	43	22	19,1	6	58	MIMC032100
40 x 1 1/4"	16	50	51	50	26	21,4	5	66	MIMC040114
50 x 1 1/2"	16	61	62	61	31	21,4	8	109	MIMC050112
63 x 2"	16	76	77	76	38	25,7	7,5	196	MIMC063200

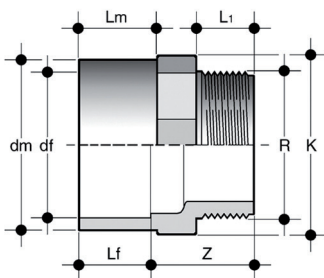

## KIFC

Adattatore di passaggio estremità df a bicchiere per incollaggio, dm maschio per incollaggio, estremità R maschio filettata BSP

dm x df x R	PN	K	L <sub>1</sub>	Lf	Lm	Z	g	Codice
20 x 16 x 3/8"	16	24	11,4	14	16	25,5	7	KIFC020016038
25 x 20 x 1/2"	16	30	15	16	19	30	16	KIFC025020012
32 x 25 x 3/4"	16	34	16,3	19	22	27,5	23	KIFC032025034
40 x 32 x 1"	16	42	19,1	22	26	32	38	KIFC040032100
50 x 40 x 1 1/4"	16	52	21,4	26	31	35,5	65	KIFC050040114
63 x 50 x 1 1/2"	16	65	21,4	31	38	39,5	113	KIFC063050112
75 x 63 x 2"	16	75	25,7	38	44	41	158	KIFC075063200

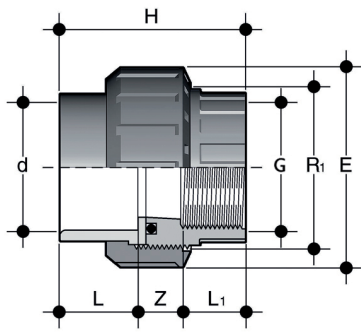

## BIFC

Bocchettone estremità d a bicchiere per incollaggio, estremità R femmina filettata BSP, guarnizione O-ring in EPDM

d x R	R <sub>1</sub>	PN	E	H	L	L <sub>1</sub>	Z	g	Codice
16 x 3/8"	3/4"	16	33	41	14	11,4	15,6	25	BIFC016038E
20 x 1/2"	1"	16	41	45	16	15	14	40	BIFC020012E
25 x 3/4"	1"1/4"	16	51	51	19	16,3	15,7	68	BIFC025034E
32 x 1"	1"1/2"	16	58	57	22	19,1	15,9	93	BIFC032100E
40 x 1"1/4"	2"	16	72	67	26	21,4	19,6	158	BIFC040114E
50 x 1"1/2"	2"1/4"	16	79	72	31	21,4	19,6	193	BIFC050112E
63 x 2"	2"3/4"	16	98	88	38	25,7	24	345	BIFC063200E

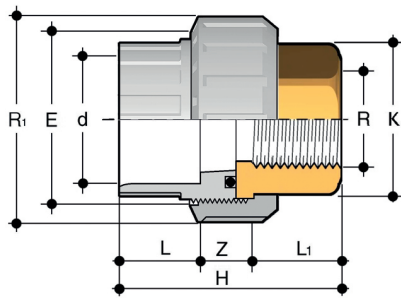

## BIFOC

Bocchettone di passaggio PVC-C/ottone, con estremità d a bicchiere per incollaggio, estremità R femmina filettata BSP in ottone, guarnizione O-Ring in EPDM

d x R	R <sub>i</sub>	PN	E	H	K	L	L <sub>i</sub>	Z	g	Codice
16 x 3/8"	3/4"	16	33	45,5	20	14	13,5	18	55	BIFOC016038E
20 x 1/2"	1"	16	41	48,5	25	16	16,5	16	88,5	BIFOC020012E
25 x 3/4"	1 1/4"	16	50	54,5	32	19	18,5	17	165	BIFOC025034E
32 x 1"	1 1/2"	16	58	59,5	38	22	19,5	18	187	BIFOC032100E
40 x 1 1/4"	2"	16	72	68,5	48	26	21,5	21	379	BIFOC040114E
50 x 1 1/2"	2 1/4"	16	79	84,5	55	31	23	30,5	475	BIFOC050112E
63 x 2"	2 3/4"	16	98	94,5	69	38	27	29,5	837	BIFOC063200E

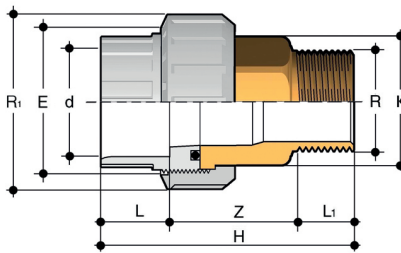

## BIROC

Bocchettone di passaggio PVC-C/ottone, con estremità d a bicchiere per incollaggio, estremità R maschio filettata BSP in ottone, guarnizione O-Ring in EPDM

d x R	R <sub>i</sub>	PN	E	H	K	L	L <sub>i</sub>	Z	g	Codice
16 x 3/8"	3/4"	16	33	58,5	20	14	10,5	34	81	BIROC016038E
20 x 1/2"	1"	16	41	65	25	16	13,5	35,5	133,5	BIROC020012E
25 x 3/4"	1 1/4"	16	50	72,5	32	19	15	38,5	223	BIROC025034E
32 x 1"	1 1/2"	16	58	80	38	22	17,5	40,5	294	BIROC032100E
40 x 1 1/4"	2"	16	72	91	48	26	19,5	45,5	558	BIROC040114E
50 x 1 1/2"	2 1/4"	16	79	101	55	31	19,5	50,5	696	BIROC050112E
63 x 2"	2 3/4"	16	98	122,5	69	38	24	60,5	1196	BIROC063200E

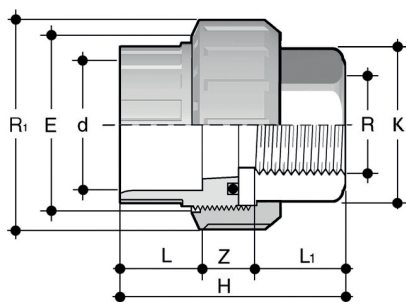

## BIFXC

Bocchettone di passaggio PVC-C/Acciaio INOX, con estremità d a bicchiere per incollaggio, estremità R femmina filettata BSP in Acciaio INOX, guarnizione O-Ring in EPDM o FKM

d x R	R <sub>i</sub>	PN	E	H	K	L	L <sub>i</sub>	Z	g	Codice EPDM	Codice FKM
16 x 3/8"	3/4"	16	33	45,5	20	14	13,5	18	52	BIFXC016038E	BIFXC016038F
20 x 1/2"	1"	16	41	48,5	25	16	16,5	16	83,5	BIFXC020012E	BIFXC020012F
25 x 3/4"	1 1/4"	16	50	54,5	32	19	18,5	17	156	BIFXC025034E	BIFXC025034F
32 x 1"	1 1/2"	16	58	59,5	38	22	19,5	18	176	BIFXC032100E	BIFXC032100F
40 x 1 1/4"	2"	16	72	68,5	48	26	21,5	21	361	BIFXC040114E	BIFXC040114F
50 x 1 1/2"	2 1/4"	16	79	84,5	55	31	23	30,5	450	BIFXC050112E	BIFXC050112F
63 x 2"	2 3/4"	16	98	94,5	69	38	27	29,5	792	BIFXC063200E	BIFXC063200F

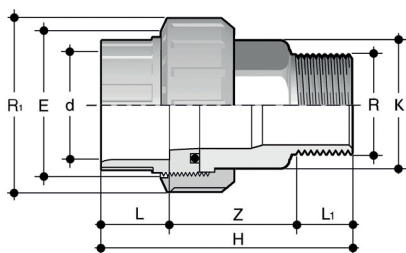

## BIRXC

Bocchettone di passaggio PVC-C/Acciaio INOX, con estremità d a bicchiere per incollaggio, estremità R maschio filettata BSP in Acciaio INOX, guarnizione O-Ring in EPDM o FKM

d x R	R <sub>i</sub>	PN	E	H	K	L	L <sub>i</sub>	Z	g	Codice EPDM	Codice FKM
16 x 3/8"	3/4"	16	33	58,5	20	14	10,5	34	76	BIRXC016038E	BIRXC016038F
20 x 1/2"	1"	16	41	65	25	16	13,5	35,5	125,5	BIRXC020012E	BIRXC020012F
25 x 3/4"	1 1/4"	16	50	72,5	32	19	15	38,5	219	BIRXC025034E	BIRXC025034F
32 x 1"	1 1/2"	16	58	80	38	22	17,5	40,5	275	BIRXC032100E	BIRXC032100F
40 x 1 1/4"	2"	16	72	91	48	26	19,5	45,5	524	BIRXC040114E	BIRXC040114F
50 x 1 1/2"	2 1/4"	16	79	101	55	31	19,5	50,5	654	BIRXC050112E	BIRXC050112F
63 x 2"	2 3/4"	16	98	122,5	69	38	24	60,5	1124	BIRXC063200E	BIRXC063200F

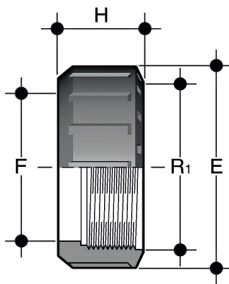

## EFC

Ghiera con filettatura cilindrica per bocchettoni tipo BIC, BIFC, BFC, BLC, BIRC, BIFOC, BIROC, BIFXC, BIRXC

R <sub>1</sub>	d BIV	PN	E	F	H	g	Codice
3/4"	16	16	33	22	21	9	EFC034
1"	20	16	41	28	22	13	EFC100
1"1/4	25	16	50	36	25	22	EFC114
1"1/2	32	16	58	42	27	30	EFC112
2"	40	16	72	53	30	50	EFC200
2"1/4	50	16	79	59	34	68	EFC214
2"3/4	63	16	98	74	38	120	EFC234

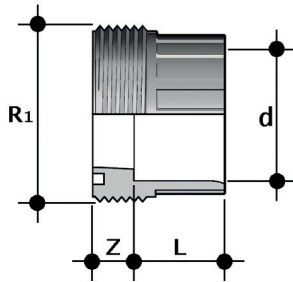

## F/BIC

Pezzo fisso per incollaggio serie metrica

d	R <sub>1</sub>	PN	L	Z	g	Codice
16	3/4"	16	14	10	9	FBIC016
20	1"	16	16	10	13	FBIC020
25	1"1/4	16	19	10	25	FBIC025
32	1"1/2	16	22	10	31	FBIC032
40	2"	16	26	12	58	FBIC040
50	2"1/4	16	31	14	63	FBIC050
63	2"3/4	16	38	19	119	FBIC063



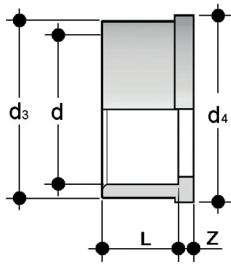

## Q/BIC

Pezzo folle per incollaggio serie metrica

d	PN	$d_3$	$d_4$	L	Z	g	Codice
16	16	22	24	14	3	5	QBIC016
20	16	27,5	30,1	16	3	10	QBIC020
25	16	36	38,8	19	3	16	QBIC025
32	16	41,5	44,7	22	3	23	QBIC032
40	16	53	56,5	26	3	40	QBIC040
50	16	59	62,6	31	3	44	QBIC050
63	16	74	78,4	38	3	82	QBIC063

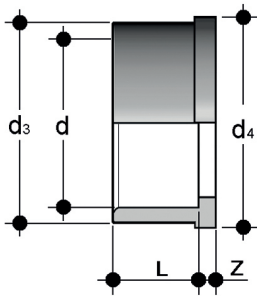

## Q/BAC

Pezzo folle per incollaggio serie ASTM

d	PN	$d_3$	$d_4$	L	Z	g	Codice
1/2"	16	27,5	30,1	22,7	3,5	17	QBAC012
3/4"	16	36	38,8	25,9	3,7	25	QBAC034
1"	16	41,5	44,7	29,2	3	36	QBAC100
1"1/4	16	53	56,5	32	5	63	QBAC114
1"1/2	16	59	62,6	35	5	86	QBAC112
2"	16	74	78,4	38,5	5,5	143	QBAC200

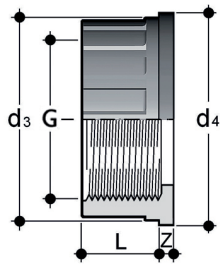

### Q/BFC

Pezzo folle estremità filettata BSP

R	PN	d <sub>3</sub>	d <sub>2</sub>	L	Z	g	Codice
3/8"	16	22	24	11,4	4,5	5	QBFC038
1/2"	16	27,5	30,1	15	5	9	QBFC012
3/4"	16	36	38,8	16,3	5	17	QBFC034
1"	16	41,5	44,7	19,1	5,5	23	QBFC100
1 1/4"	16	53	56,5	21,4	5,5	37	QBFC114
1 1/2"	16	59	62,6	21,4	5,5	44	QBFC112
2"	16	74	78,4	25,7	5,5	79	QBFC200

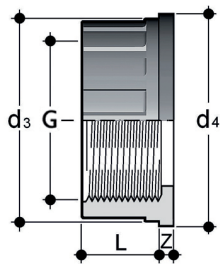

### Q/BNC

Pezzo folle estremità femmina filettata NPT

R	PN	d <sub>3</sub>	d <sub>2</sub>	L	Z	g	Codice
3/8"	16	22	24	12,7	6,3	11	QBNC038
1/2"	16	27,5	30,1	17,8	5,2	17	QBNC012
3/4"	16	36	38,8	18	5,2	22	QBNC034
1"	16	41,5	44,7	22,6	5,7	33	QBNC100
1 1/4"	16	53	56,5	25,1	7,3	61	QBNC114
1 1/2"	16	59	62,6	24,7	7	77	QBNC112
2"	16	74	78,4	29,6	7,8	127	QBNC200

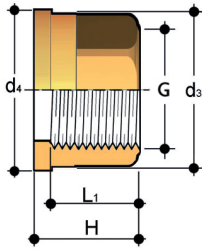

## Q/BFO

Pezzo folle estremità femmina filettata BSP in Ottone

R	d <sub>3</sub>	d <sub>4</sub>	H	L <sub>1</sub>	g	Codice
3/8"	22	24	21,5	13,5	38	QBFO038
1/2"	27,5	30,1	22,5	16,5	60	QBFO012
3/4"	36	38,8	25,5	18,5	116	QBFO034
1"	41,5	44,7	27,5	19,5	144	QBFO100
1 1/4"	53	56,5	30,5	21,5	260	QBFO114
1 1/2"	59	62,6	33,5	23	325	QBFO112
2"	74	78,4	38,5	27	578	QBFO200

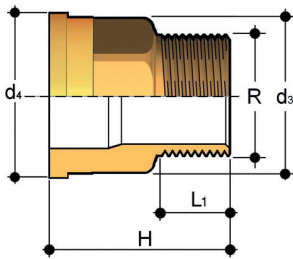

## Q/BRO

Pezzo folle estremità maschio filettata BSP in Ottone

R	d <sub>3</sub>	d <sub>4</sub>	H	L <sub>1</sub>	g	Codice
3/8"	22	24	34,5	10,5	64	QBRO038
1/2"	27,5	30,1	39	13,5	105	QBRO012
3/4"	36	38,8	43,5	15	184	QBRO034
1"	41,5	44,7	48	17,5	251	QBRO100
1 1/4"	53	56,5	53	19,5	437	QBRO114
1 1/2"	59	62,6	56	19,5	545	QBRO112
2"	74	78,4	65,5	24	937	QBRO200

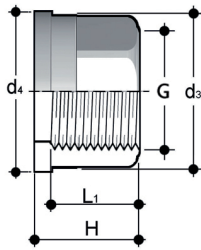

### Q/BFX

Pezzo folle estremità femmina filettata BSP in Acciaio INOX A316L

R	d <sub>2</sub>	d <sub>3</sub>	H	L <sub>1</sub>	g	Codice
3/8"	22	24	21,5	13,5	34	QBFX038
1/2"	27,5	30,1	22,5	16,5	54	QBFX012
3/4"	36	38,8	25,5	18,5	104	QBFX034
1"	41,5	44,7	27,5	19,5	130	QBFX100
1 1/4"	53	56,5	30,5	21,5	234	QBFX114
1 1/2"	59	62,6	33,5	23	293	QBFX112
2"	74	78,4	38,5	27	520	QBFX200

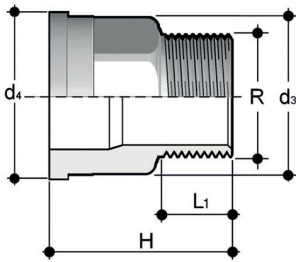

### Q/BRX

Pezzo folle estremità maschio filettata BSP in Acciaio INOX A316L

R	d <sub>2</sub>	d <sub>3</sub>	H	L <sub>1</sub>	g	Codice
3/8"	22	24	34,5	10,5	58	QBRX038
1/2"	27,5	30,1	39	13,5	95	QBRX012
3/4"	36	38,8	43,5	15	166	QBRX034
1"	41,5	44,7	48	17,5	226	QBRX100
1 1/4"	53	56,5	53	19,5	393	QBRX114
1 1/2"	59	62,6	56	19,5	491	QBRX112
2"	74	78,4	65,5	24	843	QBRX200

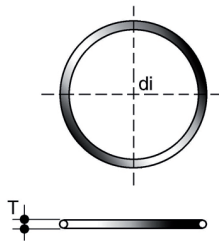

## O-RING

Guarnizioni per bocchettoni tipo BIC, BIFC, BIFOC, BIFXC, BIRXC

Union d	C	di	T	Codice EPDM	Codice FKM
16	3062	15,54	2,62	OR3062E	OR3062F
20	4081	20,22	3,53	OR4081E	OR4081F
25	4112	28,17	3,53	OR4112E	OR4112F
32	4131	32,93	3,53	OR4131E	OR4131F
40	6162	40,65	5,34	OR6162E	OR6162F
50	6187	47	5,34	OR6187E	OR6187F
63	6237	59,69	5,34	OR6237E	OR6237F
75	6300	75,57	5,34	OR6300E	OR6300F
90	6362	91,45	5,34	OR6362E	OR6362F
110	6450	113,67	5,34	OR6450E	OR6450F