

Raccordi BSP

RACCORDI FILETTATI



RACCORDI BSP

Serie di raccordi destinati al convogliamento di fluidi in pressione con giunzione mediante filettatura.

RACCORDI FILETTATI

Specifiche tecniche	
Gamma dimensionale	R 3/8" ÷ 4"
Pressione nominale	PN 16 con acqua a 20 °C
Campo di temperatura	0 °C ÷ 60 °C
Standard di accoppiamento	Filettatura: ISO 228-1, EN 10226-1/2, ISO 7, ASTM D 2464, JIS B0203 Flangiatura: EN 1092-1
Riferimenti normativi	Criteri Costruttivi: EN ISO 1452, EN ISO 15493 Metodi e requisiti dei test: EN ISO 1452, EN ISO 15493
Materiale raccordi	PVC-U Grigio scuro RAL 7011
Materiali tenuta	EPDM, FKM

DATI TECNICI

CURVE DI REGRESSIONE PER PVC-U

Coefficienti di regressione in accordo a EN ISO 1452 e EN ISO 15493 per valori di MRS (minimo) = 25 N/mm² (MPa) (classificazione PVC-U 250)

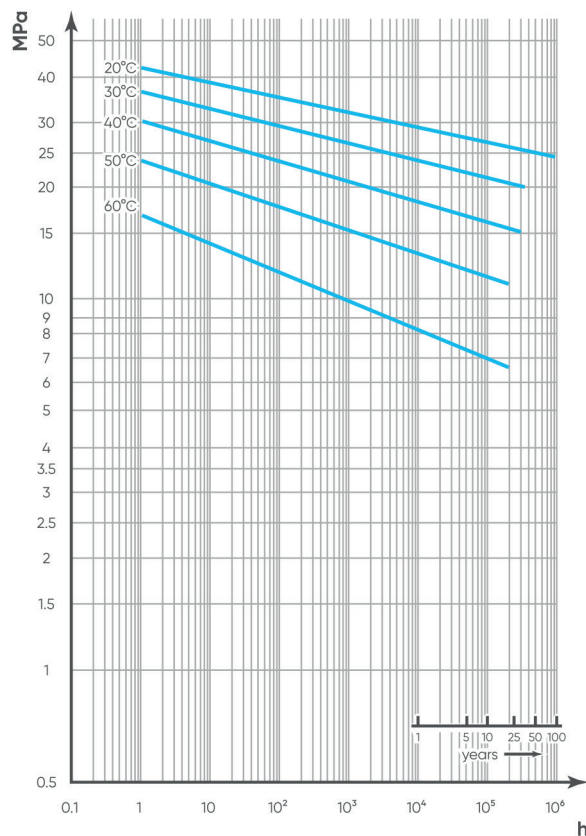

VARIAZIONE DELLA PRESSIONE IN FUNZIONE DELLA TEMPERATURA

Per acqua o fluidi non pericolosi nei confronti dei quali il materiale è classificato CHIMICAMENTE RESISTENTE (aspettativa di vita 25 anni). In altri casi è richiesta un'adeguata diminuzione della pressione nominale PN.

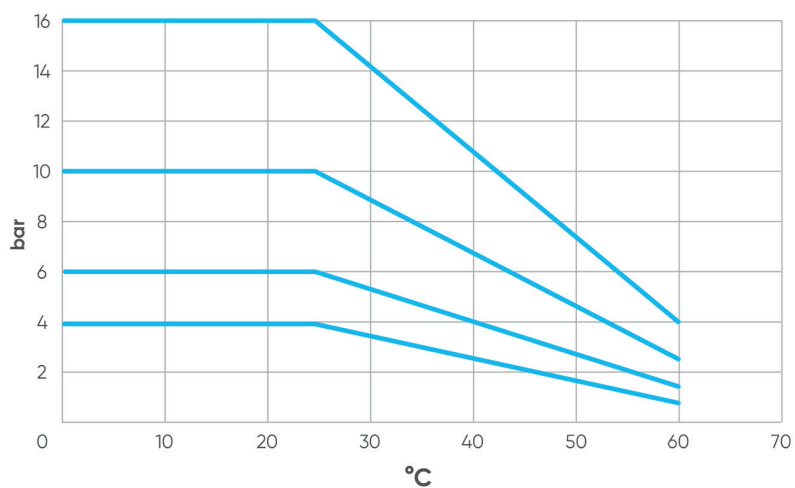

DIMENSIONI

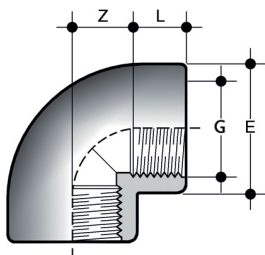

GFV

Gomito a 90° estremità femmina filettate

G	PN	E	L	Z	g	Codice
3/8"	16	23,5	11,4	13	16	GFV038
1/2"	16	28,5	15	13	24	GFV012
3/4"	16	35	16,3	17	40	GFV034
1"	16	43	19,1	21	72	GFV100
1 1/4"	16	54	21,4	27	130	GFV114
1 1/2"	16	61	21,4	36	185	GFV112
2"	16	76	25,7	46	350	GFV200
2 1/2"	16	89	30	53	455	GFV212
3"	16	106	33	65	545	GFV300
4"	16	129	39	79	1030	GFV400

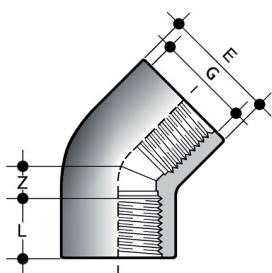

HFV

Gomito a 45° estremità femmina filettate

G	PN	E	L	Z	g	Codice
1/2"	16	28	15	6,5	18	HFV012
3/4"	16	33	16,3	8	24	HFV034
1"	16	41	19,1	10,5	45	HFV100
1 1/4"	16	50	21,4	15	68	HFV114
1 1/2"	16	64	21,4	21	154	HFV112
2"	16	76	25,7	26	255	HFV200
2 1/2"	16	90	30,2	31	345	HFV212
3"	16	107	33,3	39	625	HFV300

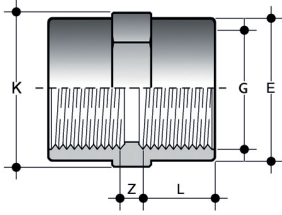

MFV

Manicotto estremità femmina filettate

G	PN	E	K	L	Z	g	Codice
3/8"	16	23,5	24	11,4	8	10	MFV038
1/2"	16	28,5	29	15	7	17	MFV012
3/4"	16	35	35	16,3	8,5	26	MFV034
1"	16	43	43	19,1	9	42	MFV100
1 1/4"	16	50	50	21,4	11	53	MFV114
1 1/2"	16	61	61	21,4	17,5	108	MFV112
2"	16	76	76	25,7	19,5	190	MFV200
2 1/2"	16	89	90	30	9	215	MFV212
3"	16	106	108	33	10	305	MFV300
4"	16	130	131	39	11	652	MFV400

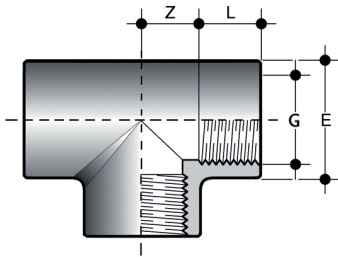

TFV

Ti a 90° estremità femmina filettate

G	PN	E	L	Z	g	Codice
3/8"	16	23,5	11,4	13	20	TFV038
1/2"	16	28,5	15	13	32	TFV012
3/4"	16	35	16,3	17	52	TFV034
1"	16	43	19,1	21,5	92	TFV100
1 1/4"	16	50	21,4	27	117	TFV114
1 1/2"	16	61	21,4	37	260	TFV112
2"	16	76	25,7	46	465	TFV200
2 1/2"	16	91	30,2	55	640	TFV212
3"	16	109	33,3	66	1135	TFV300
4"	16	133	39,3	83	1710	TFV400

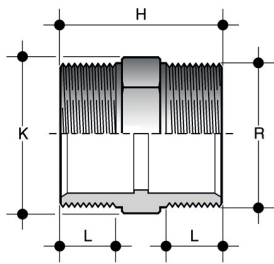

NFV

Nipplo estremità maschio filettate

R	PN	E	H	K	L	g	Codice
3/8"	16	22	33	19	11,4	5	NFV038
1/2"	16	28	42	24	15	10	NFV012
3/4"	16	34	44	30	16,3	20	NFV034
1"	16	40	50	36	19,1	30	NFV100
1"1/4	16	52	58	46	21,4	45	NFV114
1"1/2	16	58	58	50	21,4	63	NFV112
2"	16	70	66	65	25,7	105	NFV200
2"1/2	16	-	78	80	30,2	175	NFV212
3"	16	-	85	95	33,3	245	NFV300
4"	16	-	96	120	39,3	348	NFV400

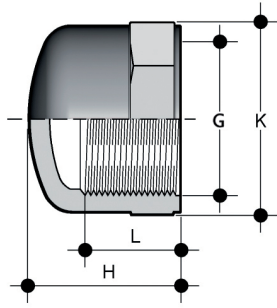

CFV

Calotta estremità femmina filettata

G	PN	H	K	L	g	Codice
3/8"	16	19	23	11,4	6	CFV038
1/2"	16	25	28	15	10	CFV012
3/4"	16	27	34	16,3	15	CFV034
1"	16	31	42	19,1	27	CFV100
1"1/4	16	35	51	21,4	40	CFV114
1"1/2	16	36	58	21,4	53	CFV112
2"	16	42	71	25,7	85	CFV200
2"1/2	16	48	89	30	200	CFV212
3"	16	55	109	33,3	310	CFV300
4"	16	59	129	39	427	CFV400

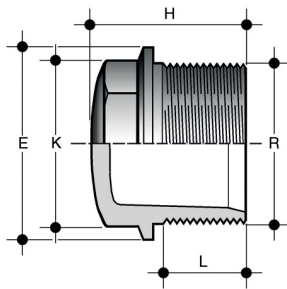

PFV

Fig. A Tappo estremità maschio filettata (fig. A)

R	PN	E	H	K	L	g	Codice
3/8"	16	22	22	18	11,4	4	PFV038
1/2"	16	28	26	23	15	8	PFV012
3/4"	16	34	30	28	16,3	11	PFV034
1"	16	40	34	35	19,1	21	PFV100
1"1/4	16	52	38	44	21,4	30	PFV114
1"1/2	16	58	40	51	21,4	46	PFV112
2"	16	70	43	65	26	80	PFV200

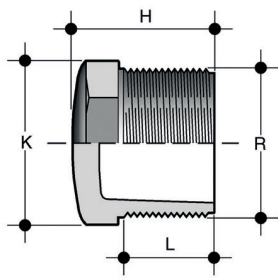
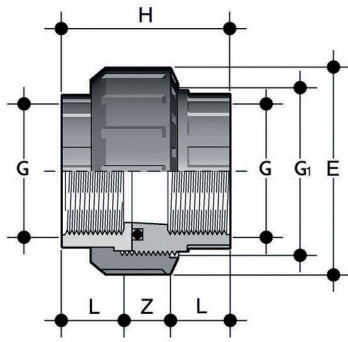

Fig. B **PFV**
Tappo estremità maschio filettata (fig. B)

R	PN	E	H	K	L	g	Codice
2"1/2	16	-	51	80	30	160	PFV212
3"	16	-	55	95	33	235	PFV300
4"	16	-	61	120	39	360	PFV400



BFV

Bocchettone estremità femmina filettate con guarnizione O-Ring in EPDM o FKM

G	G ₁	PN	E	H	L	Z	g	Codice
3/8"	3/4"	16	33	40	11.4	17.2	22	BFV038E
1/2"	1"	16	41	46	15	16	35	BFV012E
3/4"	1 1/4"	16	50	51	16.3	18,4	65	BFV034E
1"	1 1/2"	16	58	57	19,1	18.8	85	BFV100E
1 1/4"	2"	16	72	65	21.4	22.2	145	BFV114E
1 1/2"	2 1/4"	16	79	65	21.4	22.2	180	BFV112E
2"	2 3/4"	16	98	78	25.7	26.6	325	BFV200E

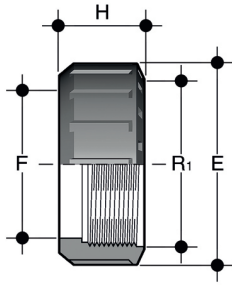

EFV

Ghiera con filettatura cilindrica per bocchettoni tipo BIV, BIFV, BFV, BLV, BIRV, BIFOV, BIROV, BIFXV, BIRXV.

R ₁	d BIV	PN	E	F	H	g	Codice
1/2"	-	16	27	17	24	8	EFV012
3/4"	16	16	33	22	21	9	EFV034
1"	20	16	41	28	22	13	EFV100
1 1/4"	25	16	50	36	25	22	EFV114
1 1/2"	32	16	58	42	27	30	EFV112
2"	40	16	72	53	30	50	EFV200
2 1/4"	50	16	79	59	34	68	EFV214
2 1/2"	-	16	90	68	36	95	EFV212
2 3/4"	63	16	98	74	38	120	EFV234
3 1/2"	75	10	120	93	45	198	EFV312
4"	90	10	135	106	52	278	EFV400
5"	110	10	163	129	60	448	EFV500

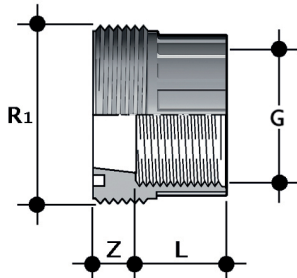

F/BFV

Pezzo fisso estremità femmina filettata BSP per bocchettoni tipo: BIV, BIFV, BFV, BLV, BIRV, BIFOV, BIROV, BIFXV, BIRXV

G	R ₁	PN	L ₁	Z	g	Codice
3/8"	3/4"	16	11,4	12,6	8	FBFV038
1/2"	1"	16	15	11	13	FBFV012
3/4"	1 1/4"	16	16,3	12,7	22	FBFV034
1"	1 1/2"	16	19,1	12,9	32	FBFV100
1 1/4"	2"	16	21,4	16,6	57	FBFV114
1 1/2"	2 1/4"	16	21,4	16,5	64	FBFV112
2"	2 3/4"	16	25,7	20,5	122	FBFV200

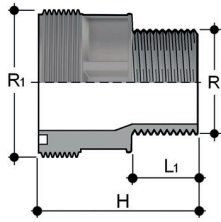

F/BRV

Pezzo fisso estremità maschio filettata BSP per bocchettoni tipo: BIV, BIFV, BFV, BLV, BIRV, BIFOV, BIROV, BIFXV, BIRXV

R	R ₁	PN	L _i	g	Codice
1 1/2"	2 1/4"	16	22,5	100	FBRV12214
2"	2 1/4"	16	27	120	FBRV200214
2"	2 3/4"	16	27	175	FBRV200234

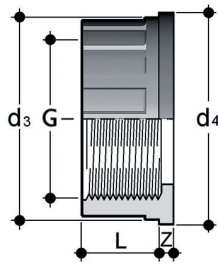

Q/BFV

Pezzo folle estremità filettata BSP per bocchettoni tipo: BIV, BIFV, BFV, BLV, BIRV, BIFOV, BIROV, BIFXV, BIRXV

R	PN	d ₃	d ₄	L	Z	g	Codice
3/8"	16	22	24	11,4	4,5	4,5	QBFV038
1/2"	16	27,5	30,1	15	5	8,5	QBFV012
3/4"	16	36	38,8	16,3	5	15,5	QBFV034
1"	16	41,5	44,7	19,1	5,5	21,0	QBFV100
1 1/4"	16	53	56,5	21,4	5,5	33,5	QBFV114
1 1/2"	16	59	62,6	21,4	5,5	40,0	QBFV112
2"	16	74	78,4	25,7	5,5	72,0	QBFV200

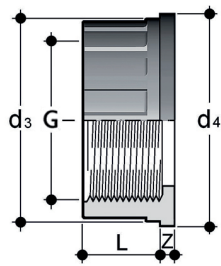

Q/BNV

Pezzo folle estremità femmina filettata NPT per bocchettoni tipo: BIV, BIFV, BFV, BLV, BIRV, BIFOV, BIROV, BIFXV, BIRXV

G	PN	d ₃	d ₄	L	Z	g	Codice
3/8"	16	22	24	12,7	6,3	10	QBNV038
1/2"	16	27,5	30,1	17,8	5,2	15	QBNV012
3/4"	16	36	38,8	18	5,2	20	QBNV034
1"	16	41,5	44,7	22,6	5,7	30	QBNV100
1 1/4"	16	53	56,5	25,1	7,3	55	QBNV114
1 1/2"	16	59	62,6	24,7	7	70	QBNV112
2"	16	74	78,4	29,6	7,8	115	QBNV200

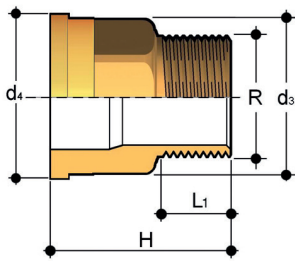

Q/BRO

Pezzo folle estremità maschio filettata BSP in Ottone per bocchettoni tipo: BIV, BIFV, BFV, BLV, BIRV, BIFOV, BIROV, BIFXV, BIRXV

R	d ₃	d ₄	H	L ₁	g	Codice
3/8"	22	24	34,5	10,5	64	QBRO038
1/2"	27,5	30,1	39	13,5	105	QBRO012
3/4"	36	38,8	43,5	15	184	QBRO034
1"	41,5	44,7	48	17,5	251	QBRO100
1 1/4"	53	56,5	53	19,5	437	QBRO114
1 1/2"	59	62,6	56	19,5	545	QBRO112
2"	74	78,4	65,5	24	937	QBRO200

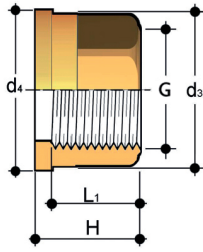

Q/BFO

Pezzo folle estremità femmina filettata BSP in Ottone per bocchettoni tipo: BIV, BIFV, BFV, BLV, BIRV, BIFOV, BIROV, BIFXV, BIRXV

G	d ₃	d ₄	H	L ₁	g	Codice
3/8"	22	24	21,5	13,5	38	QBFO038
1/2"	27,5	30,1	22,5	16,5	60	QBFO012
3/4"	36	38,8	25,5	18,5	116	QBFO034
1"	41,5	44,7	27,5	19,5	144	QBFO100
1"1/4	53	56,5	30,5	21,5	260	QBFO114
1"1/2	59	62,6	33,5	23	325	QBFO112
2"	74	78,4	38,5	27	578	QBFO200

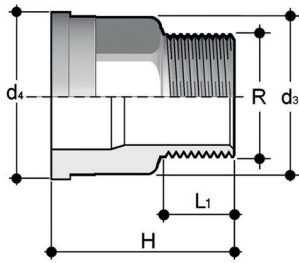

Q/BRX

Pezzo folle estremità maschio filettata BSP in Acciaio INOX A316L per bocchettoni tipo: BIV, BIFV, BFV, BLV, BIRV, BIFOV, BIROV, BIFXV, BIRXV

R	d ₃	d ₄	H	L ₁	g	Codice
3/8"	22	24	34,5	10,5	58	QBRX038
1/2"	27,5	30,1	39	13,5	95	QBRX012
3/4"	36	38,8	43,5	15	166	QBRX034
1"	41,5	44,7	48	17,5	226	QBRX100
1"1/4	53	56,5	53	19,5	393	QBRX114
1"1/2	59	62,6	56	19,5	491	QBRX112
2"	74	78,4	65,5	24	843	QBRX200

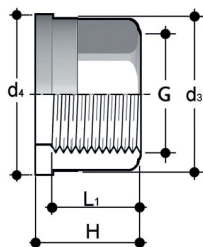

Q/BFX

Pezzo folle estremità femmina filettata BSP in Acciaio INOX A316L per bocchettoni tipo: BIV, BIFV, BFV, BLV, BIRV, BIFOV, BIROV, BIFXV, BIRXV

G	d ₃	d ₄	H	L ₁	g	Codice
3/8"	22	24	21,5	13,5	34	QBFX038
1/2"	27,5	30,1	22,5	16,5	54	QBFX012
3/4"	36	38,8	25,5	18,5	104	QBFX034
1"	41,5	44,7	27,5	19,5	130	QBFX100
1"1/4	53	56,5	30,5	21,5	234	QBFX114
1"1/2	59	62,6	33,5	23	293	QBFX112
2"	74	78,4	38,5	27	520	QBFX200

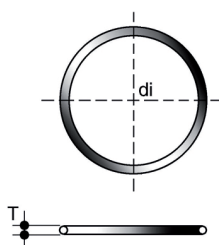

O-RING

Guarnizione per bocchettoni tipo BIV, BIFV, BFV, BLV, BIRV, BIFOV, BIROV, BIFXV, BIRXV.

Union D	C	di	T	Codice	Codice
16	3062	15,54	2,62	OR3062E	OR3062F
20	4081	20,22	3,53	OR4081E	OR4081F
25	4112	28,17	3,53	OR4112E	OR4112F
32	4131	32,93	3,53	OR4131E	OR4131F
40	6162	40,65	5,34	OR6162E	OR6162F
50	6187	47	5,34	OR6187E	OR6187F
63	6237	59,69	5,34	OR6237E	OR6237F
75	6300	75,57	5,34	OR6300E	OR6300F
90	6362	91,45	5,34	OR6362E	OR6362F
110	6450	113,67	5,34	OR6450E	OR6450F

prodotti di rivendita

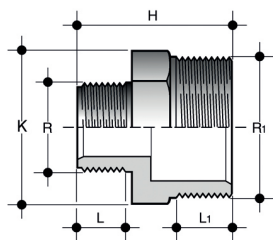

NRFV

Nipplo ridotto estremità maschio filettate

R _x x R	PN	H	K	L	L ₁	g	Codice
3/4" x 1/2"	16	43	30	15	16,3	15	NRFV034012
1" x 3/4"	16	47	36	16,3	19,1	25	NRFV100034
1 1/4 x 1"	16	54	46	19,1	21,4	40	NRFV114100
1 1/2 x 1 1/4	16	60	50	21,4	21,4	60	NRFV112114
2" x 1 1/2	16	62	65	21,4	25,7	90	NRFV200112
2 1/2 x 2"	16	72	80	25,7	30,2	155	NRFV212200
3" x 2 1/2	16	82	95	30,2	33,3	240	NRFV300212
4" x 3"	16	91	120	33,3	39,3	357	NRFV400300

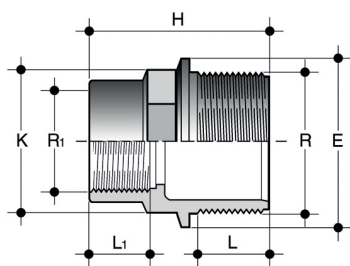

RFV

Riduzione estremità maschio filettata (1° R di riferimento) estremità femmina filettata (R1 ridotto) (fig. A)

Fig. A

R x R ₁	PN	E	H	K	L	L ₁	g	Codice
1/2" x 3/8"	16	28	35	23	15	11,4	10	RFV012038
3/4 x 3/8"	16	34	36	28	16,3	11,4	12	RFV034038
3/4 x 1/2"	16	34	39	28	16,3	15	15	RFV034012
1" x 3/8"	16	40	41	35	19,1	11,4	20	RFV100038
1" x 1/2"	16	40	44	35	19,1	15	24	RFV100012
1 x 3/4"	16	40	46	35	19,1	16,3	25	RFV100034
1 1/4 x 1/2"	16	52	48	44	21,4	15	37	RFV114012
1 1/4 x 3/4"	16	52	49	44	21,4	16,3	37	RFV114034
1 1/4 x 1"	16	52	52	44	21,4	19,1	40	RFV114100
1 1/2 x 1/2"	16	58	52	51	21,4	15	46	RFV112012
1 1/2 x 3/4"	16	58	50	51	21,4	16,3	47	RFV112034
1 1/2 x 1"	16	58	55	51	21,4	19,1	52	RFV112100
1 1/2 x 1 1/4	16	58	57	51	21,4	21,4	54	RFV112114
2" x 3/4"	16	70	60	64	25,7	16,3	80	RFV200034
2" x 1"	16	70	63	64	25,7	19,1	80	RFV200100
2" x 1 1/4	16	70	65	64	25,7	21,4	85	RFV200114
2" x 1 1/2	16	70	65	64	25,7	21,4	102	RFV200112

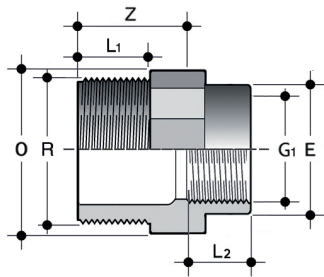

RFV

Riduzione estremità maschio filettata (1° R di riferimento) estremità femmina filettata (G1 ridotto)
(fig. B)

Fig. B

R x G ₁	PN	E	Z	O	L ₁	L ₂	g	Codice
2"1/2 x 2"	16	72	43	80	30	26	160	RFV212200
3" x 2"	16	72	47	95	33	26	215	RFV300200
3" x 2"1/2	16	89	47	95	33	30	230	RFV300212
4" x 3"	16	103	53	120	39	33	200	RFV400300

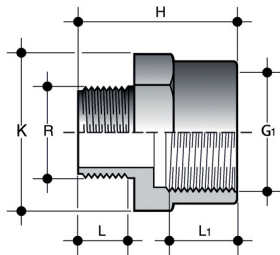

IFFV

Riduzione femmina/maschio estremità femmina filettata BSP (G1 di riferimento), estremità ridotta maschio filettata BSP (R)

G ₁ x R	PN	H	K	L	L ₁	g	Codice
3/4" x 1/2"	16	41	36	15	16,3	22	IFFV034012
1" x 1/2"	16	40,5	43	15	19,1	30	IFFV100012
1" x 3/4"	16	42	43	16,3	19,1	42	IFFV100034
1"1/4 x 1"	16	55	55	19,1	21,4	55	IFFV114100
1"1/2 x 1"1/4	16	62	65	21,4	21,4	102	IFFV112114
2" x 1"1/2	16	69	80	21,4	25,7	165	IFFV200112
2"1/2 x 2"	16	81	95	25,7	30,2	210	IFFV212200
3" x 2"1/2	16	93	110	30,2	33,3	360	IFFV300212
4" x 3"	16	106	130	33,3	39,3	500	IFFV400300

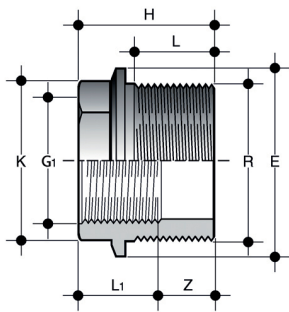

DFV

Bussola di riduzione estremità maschio filettata (1° R di riferimento), estremità femmina filettata (G1 ridotto)

R x G ₁	PN	E	H	K	L	L ₁	Z	g	Codice
1/2" x 3/8"	16	28	24	23	11,4	15	12,6	7	DFV012038
3/4" x 1/2"	16	34	26,5	28	15	16,3	11,5	9	DFV034012
1" x 3/4"	16	40	30,5	35	16,3	19,10	14,2	17	DFV100034
1 1/4" x 1"	16	52	34	44	19,1	21,4	14,9	30	DFV114100
1 1/2" x 1 1/4"	16	58	35	51	21,4	21,4	13,6	30	DFV112114
2" x 1 1/2"	16	70	40	64	21,4	25,7	18,6	72	DFV200112

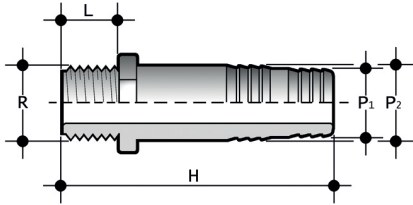

AFV

Portagomma estremità maschio filettata

R x P ₁ x P ₂	PN	H	L	g	Codice
1/4" x 12 x 14	16	56	11	7	AFV014012014
3/8" x 16 x 18	16	58	11,4	14	AFV038016018
1/2" x 20 x 22	16	66	15	19	AFV012020022
3/4" x 25 x 27	16	81	16,3	30	AFV034025027
1" x 30 x 32	16	97	19,1	45	AFV100030032
1"1/4 x 40 x 42	16	104	21,4	85	AFV114040042
1"1/2 x 50 x 52	16	111	21,4	120	AFV112050052
2" x 60 x 64	16	123	25,7	180	AFV200060064

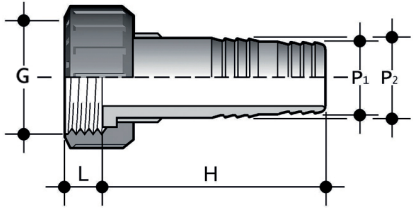

ADV

Portagomma con estremità G a bocchettone femmina filettato e guarnizione piana in EPDM

G x P ₁ x P ₂	PN	H	L	g	Codice
1/2" x 12 x 14	16	56	14	15	ADV012012014
3/4" x 16 x 18	16	60	11,5	24	ADV034016018
1" x 20 x 22	16	67	11	35	ADV100020022
1"1/4 x 25 x 27	16	81	14	55	ADV114025027
1"1/2 x 30 x 32	16	97	16	80	ADV112030032
2" x 40 x 42	16	104	18	140	ADV200040042
2" x 50 x 52	16	111	16	180	ADV200050052
2"1/4 x 50 x 52	16	111	17,5	200	ADV214050052
2"3/4 x 60 x 64	16	123	20	300	ADV234060064